

JVC

SERVICE MANUAL

COLOUR TELEVISION

AV32H10EUS AV28H10EUS

BASIC CHASSIS

MF

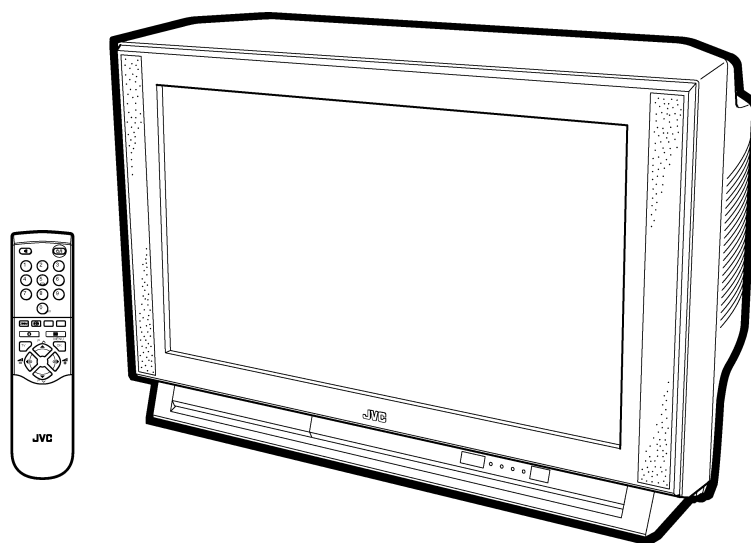

CONTENTS

■ SPECIFICATIONS	2
■ SAFETY PRECAUTIONS(EU)	4
■ FEATURES	5
■ MAIN DIFFERENCE LIST	6
■ FUNCTIONS	7
■ SPECIFIC SERVICE INSTRUCTIONS	8
■ SERVICE ADJUSTMENTS	16
■ PARTS LIST	33
★ OPERATING INSTRUCTIONS	
★ STANDARD CIRCUIT DIAGRAM	2-1

SPECIFICATIONS

Item	CONTENTS	
	AV32H10EUS	AV28H10EUS
Dimensions (W × H × D)	855mm × 550mm × 568mm	780mm × 509mm × 499mm
Mass	53.6kg	40.2kg
TV RF System	CCIR B/G, I, D/K, L	
Colour System	PAL / SECAM / NTSC 3.58 / NTSC 4.43 (NTSC play back only)	
Sound System	A2 (B/G, D/K), NICAM (B/G, I, D/K, L)	
Teletext System	Fastext(United Kingdom system), TOP(German system), WST(World standard system)	
Receiving Frequency		
	VHF	47MHz~ 470MHz
	UHF	470MHz~862MHz
	French CATV	116MHz~172MHz / 220MHz~469MHz
Intermediate Frequency		
	VIF Carrier	38.9MHz(B/G, D/K, I, L), 33.95MHz(L')
	SIF Carrier	33.4MHz(5.5MHz : B/G) / 32.9MHz(6.0MHz : I) 32.4MHz(6.5MHz : D/K, L) / 40.45MHz(6.5MHz : L')
Colour Sub Carrier		
	PAL	4.43MHz
	SECAM	4.40625MHz / 4.25MHz
	NTSC	3.58MHz / 4.43MHz
Power Input	AC 220V~240V , 50Hz	
Power Consumption	189W(Maximum), 140W(Average)	183W(Maximum), 127W(Average)
Picture Tube	Visible size : 76cm, Measured diagonally	Visible size : 66cm, Measured diagonally
High Voltage	31.0kV ^{+1.0kV} _{-1.5kV} (at zero beam current)	
Speaker	16cm × 4cm, Oval type × 2	
Audio Output	Rated power output : 7.5W + 7.5W	
Input / Output terminals		
	EXT-1	21-pin Euro connector (SCART socket), Video, Audio L/R, RGB signal input are available TV broadcast output (Video and Audio L/R) are available
	EXT-2	21-pin Euro connector (SCART socket), S-Video, Video, Audio L/R, RGB signal input are available AV selector (TV LINK) function is available
	EXT-3	21-pin Euro connector (SCART socket), Video, Audio L/R, RGB signal input are available
	EXT-4	RCA pin type, S-Video, Video and Audio L/R signal input are available
	Audio output	RCA pin type, Variable audio L/R output are available
Aerial socket	75Ω unbalanced, Coaxial	
Headphone jack	Stereo mini jack (φ 3.5mm)	
Remote Control Unit	RM-C54 (AAA/R03 dry cell battery × 2)	

Design and specifications are subject to change without notice.

■ 21-pin Euro connector (SCART socket) : EXT-1 / EXT-2 / EXT-3

(P-P= Peak to Peak, S-W= Sync tip to white peak, B-W= Blanking to white peak)

Pin	Signal Designation	Matching Value	EXT-1	EXT-2	EXT-3
1	AUDIO R output	500mVrms(Nominal), Low impedance	○ (TV OUT)	○ (LINE OUT)	NC
2	AUDIO R input	500mVrms(Nominal), High impedance	○	○	○
3	AUDIO L output	500mVrms(Nominal), Low impedance	○ (TV OUT)	○ (LINE OUT)	NC
4	AUDIO GND		○	○	○
5	GND (B)		○	○	○
6	AUDIO L input	500mVrms(Nominal), High impedance	○	○	○
7	B input	700mV _{B-W} , 75 Ω	○	○	NC
8	FUNCTION SW (SLOW SW)	Low : 0-3V, High : 8-12V, High impedance	○	○	○
9	GND (G)		○	○	○
10	SCL3		NC	○	NC
11	G input	700mV _{B-W} , 75 Ω	○	○	NC
12	SDA3		NC	○	NC
13	GND (R)		○	○	○
14	GND (Y _S)		○	○	NC
15	R / C input	R : 700mV _{B-W} , 75 Ω C : 300mV _{P-P} , 75 Ω	○ (only R)	○	○ (only C)
16	Ys input	Low : 0 - 0.4, High : 1 - 3V, 75 Ω	○	○	NC
17	GND(VIDEO output)		○	○	○
18	GND(VIDEO input)		○	○	○
19	VIDEO output	1V _{P-P} (Negative going sync), 75 Ω	○ (TV)	○ (LINE OUT)	NC
20	VIDEO / Y input	1V _{P-P} (Negative going sync), 75 Ω	○ (only VIDEO input)	○	○
21	COMMON GND		○	○	○

[Pin assignment]

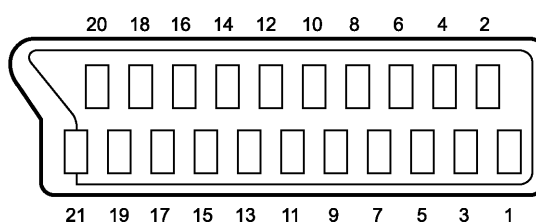

SAFETY PRECAUTIONS

1. The design of this product contains special hardware, many circuits and components specially for safety purposes. For continued protection, no changes should be made to the original design unless authorized in writing by the manufacturer. Replacement parts must be identical to those used in the original circuits. Service should be performed by qualified personnel only.
2. Alterations of the design or circuitry of the products should not be made. Any design alterations or additions will void the manufacturer's warranty and will further relieve the manufacturer of responsibility for personal injury or property damage resulting therefrom.
3. Many electrical and mechanical parts in the products have special safety-related characteristics. These characteristics are often not evident from visual inspection nor can the protection afforded by them necessarily be obtained by using replacement components rated for higher voltage, wattage, etc. Replacement parts which have these special safety characteristics are identified in the parts list of Service manual. **Electrical components having such features are identified by shading on the schematics and by (Δ) on the parts list in Service manual.** The use of a substitute replacement which does not have the same safety characteristics as the recommended replacement part shown in the parts list of Service manual may cause shock, fire, or other hazards.
4. **Don't short between the LIVE side ground and ISOLATED (NEUTRAL) side ground or EARTH side ground when repairing.**
Some model's power circuit is partly different in the GND. The difference of the GND is shown by the LIVE : (\perp) side GND, the ISOLATED(NEUTRAL) : (⏏) side GND and EARTH : (\oplus) side GND. Don't short between the LIVE side GND and ISOLATED(NEUTRAL) side GND or EARTH side GND and never measure with a measuring apparatus (oscilloscope etc.) the LIVE side GND and ISOLATED(NEUTRAL) side GND or EARTH side GND at the same time.
If above note will not be kept, a fuse or any parts will be broken.
5. If any repair has been made to the chassis, it is recommended that the B1 setting should be checked or adjusted (See ADJUSTMENT OF B1 POWER SUPPLY).
6. The high voltage applied to the picture tube must conform with that specified in Service manual. Excessive high voltage can cause an increase in X-Ray emission, arcing and possible component damage, therefore operation under excessive high voltage conditions should be kept to a minimum, or should be prevented. If severe arcing occurs, remove the AC power immediately and determine the cause by visual inspection (incorrect installation, cracked or melted high voltage harness, poor soldering, etc.). To maintain the proper minimum level of soft X-Ray emission, components in the high voltage circuitry including the picture tube must be the exact replacements or alternatives approved by the manufacturer of the complete product.
7. Do not check high voltage by drawing an arc. Use a high voltage meter or a high voltage probe with a VTVM. Discharge the picture tube before attempting meter connection, by connecting a clip lead to the ground frame and connecting the other end of the lead through a 10k Ω 2W resistor to the anode button.
8. When service is required, observe the original lead dress. Extra precaution should be given to assure correct lead dress in the high voltage circuit area. Where a short circuit has occurred, those components that indicate evidence of overheating should be replaced. Always use the manufacturer's replacement components.

9. Isolation Check

(Safety for Electrical Shock Hazard)

After re-assembling the product, always perform an isolation check on the exposed metal parts of the cabinet (antenna terminals, video/audio input and output terminals, Control knobs, metal cabinet, screwheads, earphone jack, control shafts, etc.) to be sure the product is safe to operate without danger of electrical shock.

(1) Dielectric Strength Test

The isolation between the AC primary circuit and all metal parts exposed to the user, particularly any exposed metal part having a return path to the chassis should withstand a voltage of 3000V AC (r.m.s.) for a period of one second.

(. . . Withstand a voltage of 1100V AC (r.m.s.) to an appliance rated up to 120V, and 3000V AC (r.m.s.) to an appliance rated 200V or more, for a period of one second.)

This method of test requires a test equipment not generally found in the service trade.

(2) Leakage Current Check

Plug the AC line cord directly into the AC outlet (do not use a line isolation transformer during this check.). Using a "Leakage Current Tester", measure the leakage current from each exposed metal part of the cabinet, particularly any exposed metal part having a return path to the chassis, to a known good earth ground (water pipe, etc.). Any leakage current must not exceed 0.5mA AC (r.m.s.).

However, in tropical area, this must not exceed 0.2mA AC (r.m.s.).

● Alternate Check Method

Plug the AC line cord directly into the AC outlet (do not use a line isolation transformer during this check.). Use an AC voltmeter having 1000 ohms per volt or more sensitivity in the following manner. Connect a 1500 Ω 10W resistor paralleled by a 0.15 μ F AC-type capacitor between an exposed metal part and a known good earth ground (water pipe, etc.). Measure the AC voltage across the resistor with the AC voltmeter. Move the resistor connection to each exposed metal part, particularly any exposed metal part having a return path to the chassis, and measure the AC voltage across the resistor. Now, reverse the plug in the AC outlet and repeat each measurement. Any voltage measured must not exceed 0.75V AC (r.m.s.). This corresponds to 0.5mA AC (r.m.s.).

However, in tropical area, this must not exceed 0.3V AC (r.m.s.). This corresponds to 0.2mA AC (r.m.s.).

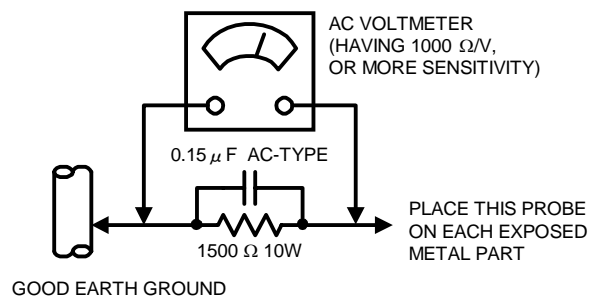

FEATURES

- New chassis design enable use of an interactive on screen control.
- The TELETEXT SYSTEM has a built-in FASTEXT (UK system), TOP (German system) and WST (world standard system) system.
- Pure FLAT CRT reproduce fine textured.
- Because this TV unit corresponds to multiplex broadcast, users can enjoy music programs and sporting events with live realism. In addition, BILINGUAL programs can be heard in their original language.
- Built-in ECO (ECONOMY, ECOLOGY) MODE.
In accordance with the brightness in a room, the brightness and/or contrast of the picture can be adjusted automatically to make the optimum picture which is easy on the eye.
- Users can make VCR dubbing of picture and sound by controlling the AV selector to select an optional source at the EXT-2 output shown in figure.

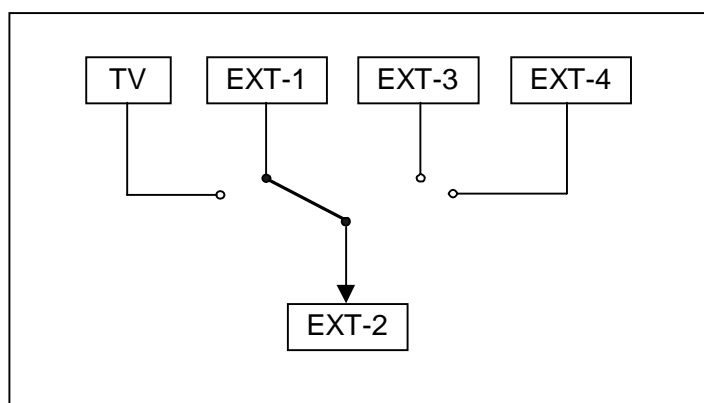

MAIN DIFFERENCE LIST

△	Part name / Model name	AV32H10EUS	AV28H10EUS
	MAIN PWB	SMF-1006A-U2	SMF-1007A-U2
	POWER / DEF. PWB	SMF-2002A-U2	SMF-2003A-U2
	CRT SOCKET PWB	SMF-3003A-U2	SMF-3004A-U2
	FRONT CONTROL PWB	SMF-8006A-U2	SMF-8004A-U2
△	PICTURE TUBE (V01)	W76ERF041X044	W66QDE891X925/A
△	DEG COIL (L01)	QQW0066-001	QQW0100-001
△	ROTATION COIL (L03)	CELD904-001	_____
△	HVT (SERVICE)	QQH0091-002-I2	QQH0091-003-I2
△	FRONT CABINET ASS'Y	LC10376-014A-U	LC10662-012A-U
△	REAR COVER	LC10378-004B-U	LC10664-003B-U
△	RATING LABEL	LC20379-018A-U	LC20379-010A-U
△	RATING LABEL	LC20380-022A-U	LC20380-020A-U
	EURO LABEL	AEM1052-063-E	AEM1052-064-E

FUNCTIONS

FRONT CONTROL PANEL

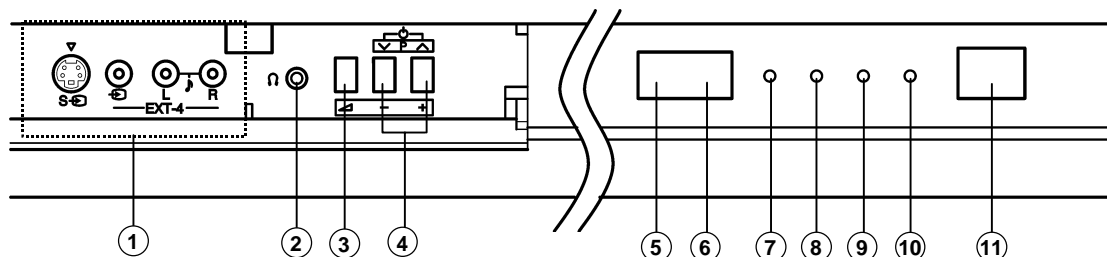

- ① EXIT-4 TERMINAL
- ② HEADPHONE JACK (MINI JACK)
- ③ VOLUME (∇) BUTTON
- ④ P ∇/∧ BUTTONS OR VOLUME(∇) -/+ BUTTONS
- ⑤ REMOTE CONTROL SENSOR
- ⑥ ECO SENSOR
- ⑦ HYPER SOUND LAMP
- ⑧ ECO LAMP
- ⑨ SLEEP TIMER LAMP
- ⑩ POWER LAMP
- ⑪ MAIN POWER BUTTON

REAR TERMINAL

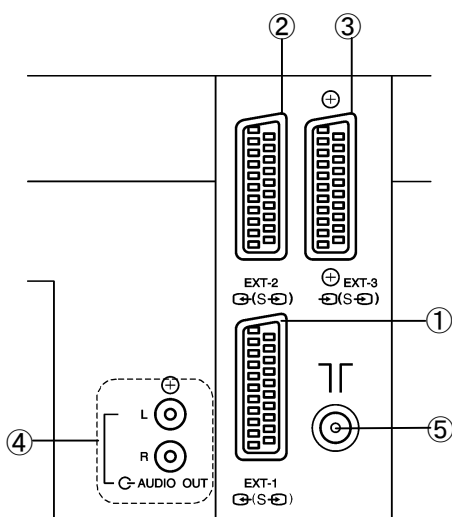

- ① EXT-1 (IN/OUT) TERMINAL
- ② EXT-2 (IN/OUT) TERMINAL
- ③ EXT-3 (IN) TERMINAL
- ④ AUDIO OUT (L, R) TERMINAL
- ⑤ AERIAL SOCKET

REMOTE CONTROL UNIT

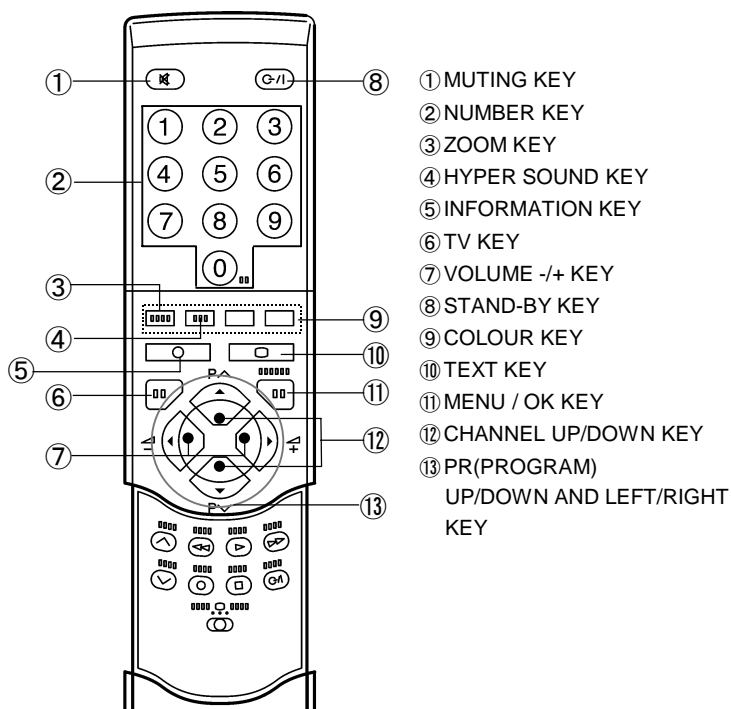

SPECIFIC SERVICE INSTRUCTIONS

DISASSEMBLY PROCEDURE

REMOVING THE REAR COVER

1. Unplug the power cord.
2. [32inch]
Remove the 13 screws marked **A** as shown in the Fig. 1.
[28inch]
Remove the 12 screws marked **A** as shown in the Fig. 1.
3. Withdraw the rear cover toward you.

REMOVING THE CHASSIS

- After removing the rear cover.
1. Slightly raise the both sides of the chassis by hand and remove the 2 claws under the both sides of the chassis from the front cabinet.
 2. Withdraw the chassis backward.
(If necessary, take off the wire clamp, connectors etc.)

REMOVING THE AV TERMINAL BOARD

- After removing the rear cover.
1. As shown in the Fig. 1, remove the **3** screws marked **B**.
 2. As shown in Fig. 2, remove the 2 claws marked **E** under the CHASSIS.
 3. As shown in Fig. 2, remove the AV TERMINAL BOARD slightly in the direction of arrow **F**.

REMOVING THE SPEAKER

- After removing the rear cover.
1. As shown in Fig. 1, remove the **2** screws marked **D**.
- NOTE:** When removing the screws marked **Ⓧ** of the speaker remove the lower side screw first, and then remove the upper one.
2. Remove the **2** screws **C** attaching the speaker.
 3. Follow the same steps when removing the other hand speaker.

CHECKING THE PW BOARD

To check the back side of the PW Board.

- 1) Pull out the chassis. (Refer to REMOVING THE CHASSIS).
- 2) Erect the chassis vertically so that you can easily check the back side of the PW Board.

[CAUTION]

- When erecting the chassis, be careful so that there will be no contacting with other PW Board.
- Before turning on power, make sure that the wire connector is properly connected.
- When conducting a check with power supplied, be sure to confirm that the CRT EARTH WIRE (BRAIDED ASS'Y) is connected to the CRT SOCKET PW board.

WIRE CLAMPING AND CABLE TYING

1. Be sure to clamp the wire.
2. Never remove the cable tie used for tying the wires together.
Should it be inadvertently removed, be sure to tie the wires with a new cable tie.

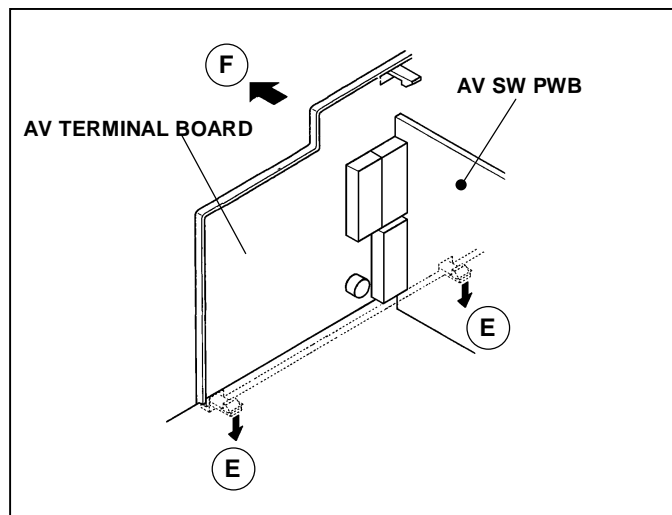

Fig. 2

- * This exploded view describes about the AV32H10EUS (32inch).
Although the 28inch is slightly different from this figure, you can use the exploded view for disassembling the 28inch in the same step as for this one.

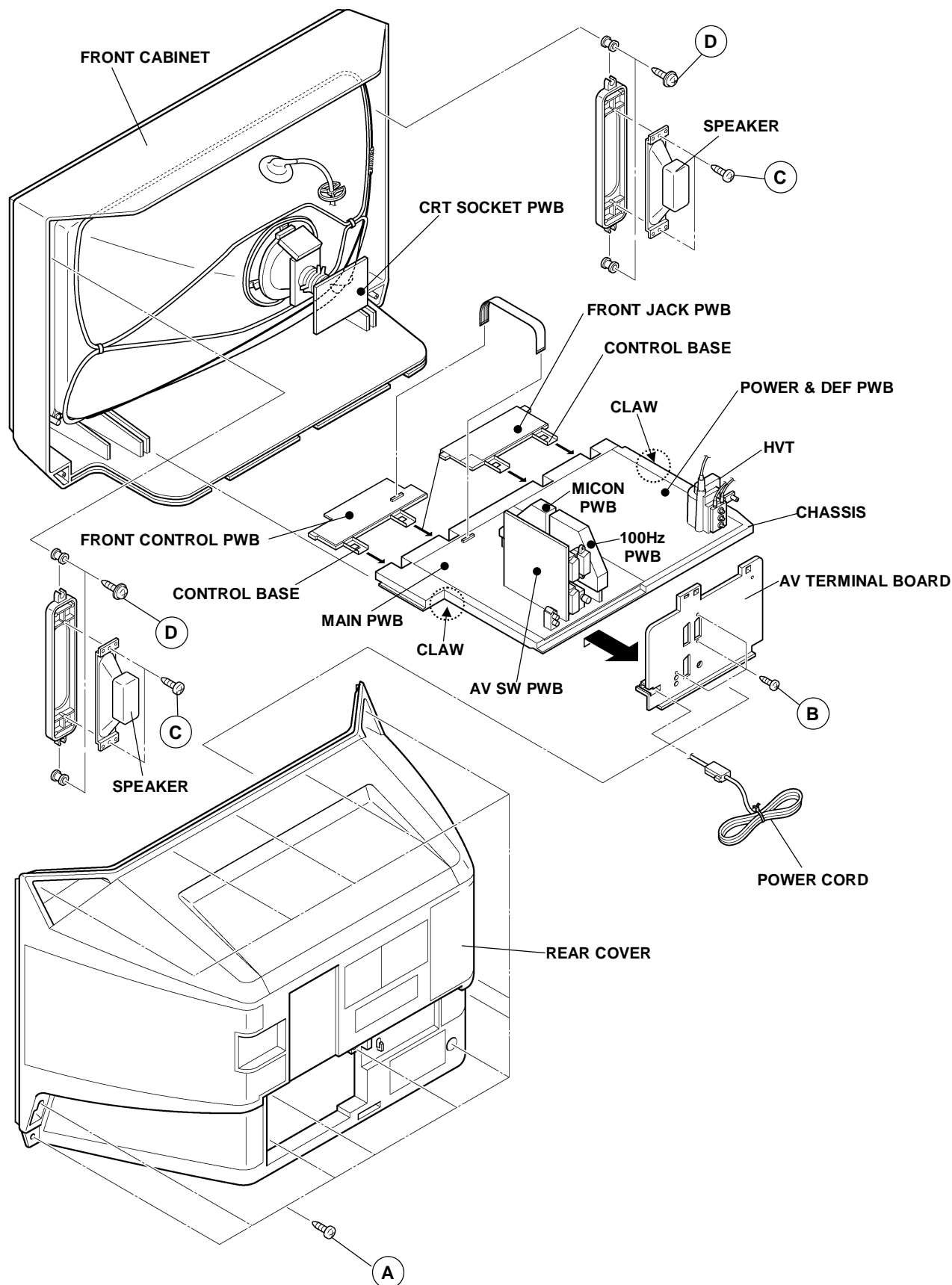

Fig.1

REMOVING THE CRT

Replacement of the CRT should be performed by 2 or more persons.
After removing the rear cover, chassis and anode wires etc.

1. Prepare the CRT change table, the CRT change table should also be covered with such soft cloth as shown in Fig.3.
The CRT change table should preferably be smaller than the CRT surface, and its height be about 35cm.
2. While keeping the CRT down surface, mount the TV set on the CRT change table as shown in Fig.3.
3. Remove 4 screws marked by arrows with a box type screw driver as shown in Fig.4.
4. Since the cabinet will drop when screws have been removed, be sure to support the cabinet with hands.
5. After 4 screws have been removed, put the cabinet slowly on cloth. At this time, be carefully so as not to damage the front surface of the cabinet as shown in Fig.5.
6. The CRT should be assembled according to the opposite sequence of its disintegrated steps.

[About CRT Spacer]

An appropriate CRT spacer should be used in the corresponding CRT in accordance with the type of the CRT.
When a CRT is replaced, special attention should be paid to this matter.

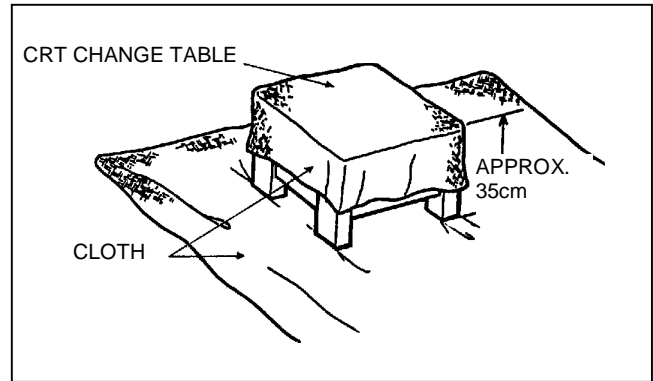

Fig. 3

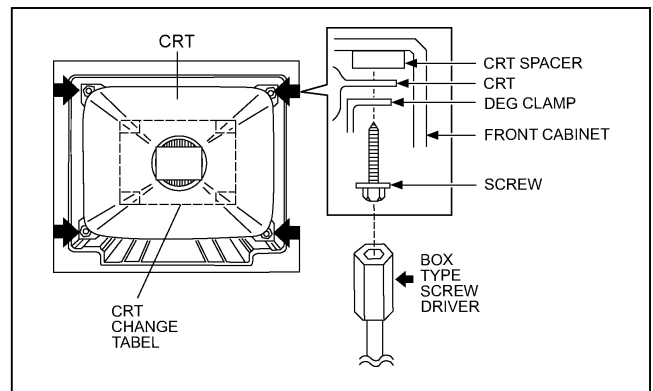

Fig. 4

COATING OF SILICON GREASE FOR ELECTRICAL INSULATION ON THE CRT ANODE CAP SECTION.

Subsequent to replacement of the CRT and HV transformer or repair of the anode cap, etc. by dismantling them, be sure to coat silicon grease for electrical insulation as shown in Fig.6.

Wipe around the anode button with clean and dry cloth. (Fig.6)

Coat silicon grease on the section around the anode button. At this time, take care so that any silicon greases dose not stick to the anode button. (Fig.7)

Silicon grease product No. KS - 650N

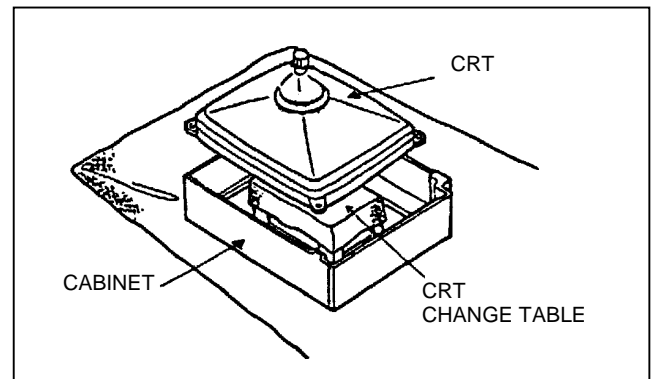

Fig. 5

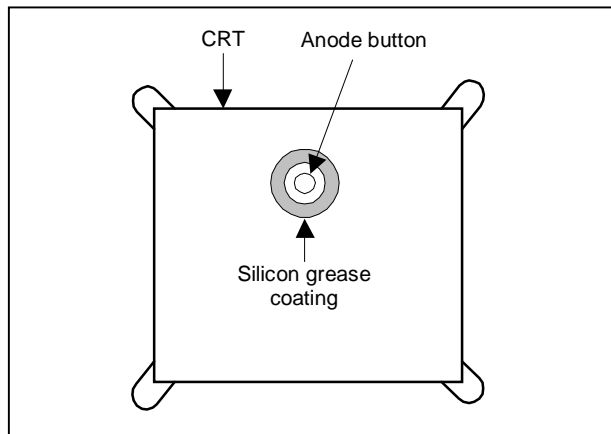

Fig. 6

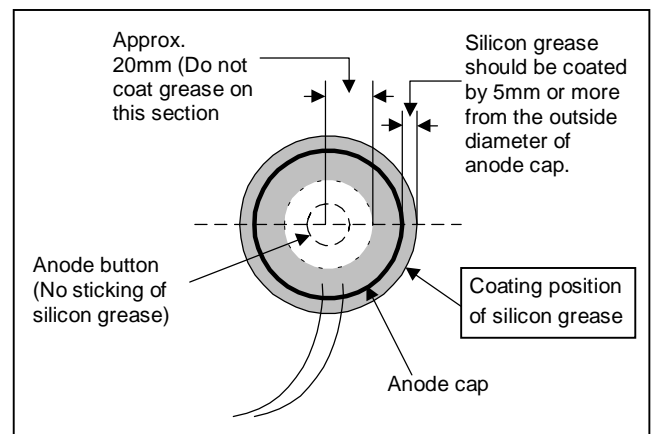

Fig. 7

REPLACEMENT OF MEMORY ICs

1. Memory ICs

This TV use memory IC. In the memory IC, there are memorized data for correctly operating the video and deflection circuits. When replacing memory IC, be sure to use IC written with the initial values of data.

2. Procedure for replacing memory ICs

PROCEDURE
<p>(1) Power off Switch the power off and disconnect the power plug.</p>
<p>(2) Replace ICs. Be sure to use memory IC written in the initial setting data.</p>
<p>(3) Power on Connect the power plug and switch the power on.</p>
<p>(4) Check and set SYSTEM CONSTANT SET It must not adjust without signal.</p> <ol style="list-style-type: none"> 1) Press the INFORMATION key and the MUTING key of the REMOTE CONTROL UNIT simultaneously. 2) The SERVICE MENU screen of Fig. 1 will be displayed. 3) While the SERVICE MENU is displayed, press the INFORMATION key and MUTING key simultaneously, and the SYSTEM CONSTANT SET screen of Fig. 2 will be displayed. 4) Check the setting values of the SYSTEM CONSTANT SET of Table 1. If value is different, select the setting item with the FUNCTION UP/DOWN key, and set the correct value with the FUNCTION LEFT/RIGHT key. 5) Press the MENU(OK) key to memorize the setting value. 6) Press the INFORMATION key, and return to the normal screen.
<p>(5) Setting of receive channels Set the receive channel. For setting, refer to the OPERATING INSTRUCTIONS.</p>
<p>(6) Setting of SERVICE MENU Verify the setting items of the SERVICE MENU of Table 2, and reset where necessary. For setting, refer to the SERVICE ADJUSTMENTS.</p>
<p>(7) User settings Check the user setting values of Table 3, and if setting value is different, set the correct value. For setting, refer to the OPERATING INSTRUCTIONS.</p>

SERVICE MENU	
1. IF	2. V/C
3. AUDIO	4. DEF
5. VSM PRESET	6. STATUS
7. PIP	8. ---
9. SHIPPING (OFF)	0. BUS FREE
1-9 : SELECT i : EXIT	

Fig.1

SYSTEM CONSTANT SET	
1. DESTINATION	EU
-/+ (OK) : STORE i : EXIT	

Fig.2

2. CRT TYPE	16 : 9
3. PURITY	NO
4. PICTURE TILT	YES
5. DIGIPURE PRO	NO
6. PIP	NO
7. PIC & TEXT	NO
8. DOLBY	NO
9. BBE	YES
10. PROGRESSIVE	NO
11. TDA9178	NO
12. TONE IC	NO
13. FLAT	YES

REMOTE CONTROL UNIT KEY ASSIGNMENT

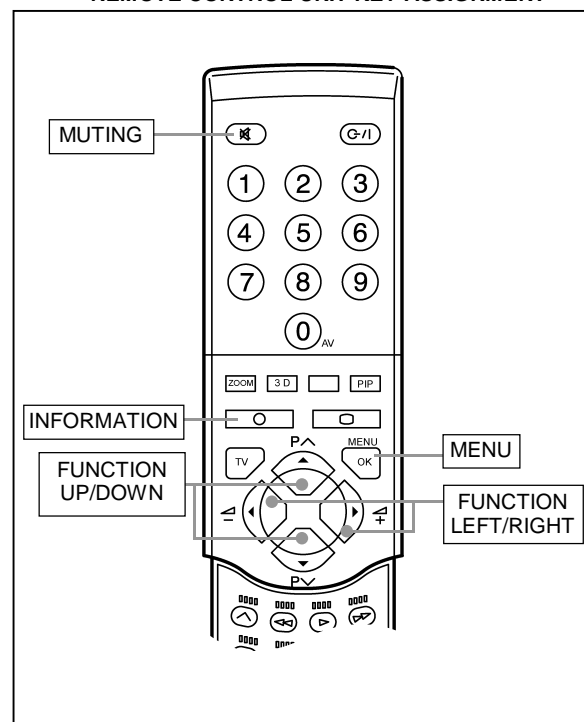

SETTING VALUE OF SYSTEM CONSTANT SET (TABLE 1)

Setting item	Setting content	Setting value	
		AV32H10EUS	AV28H10EUS
1. DESTINATION	<input type="checkbox"/> EK → EU → EI <input type="checkbox"/>	EU	EU
2. CRT TYPE	<input type="checkbox"/> 16:9 → 4:3 <input type="checkbox"/>	16:9	←
3. PURITY	<input type="checkbox"/> YES → NO <input type="checkbox"/>	NO	←
4. PICTURE TILT	<input type="checkbox"/> YES → NO <input type="checkbox"/>	YES	←
5. DIGIPURE PRO	<input type="checkbox"/> YES → NO <input type="checkbox"/>	NO	←
6. PIP	<input type="checkbox"/> 1 TUNER → 2 TUNER → NO <input type="checkbox"/>	NO	←
7. PIC & TEXT	<input type="checkbox"/> YES → NO <input type="checkbox"/>	NO	←
8. DOLBY	<input type="checkbox"/> YES → NO <input type="checkbox"/>	NO	←
9. BBE	<input type="checkbox"/> YES → NO <input type="checkbox"/>	YES	←
10. PROGRESSIVE	<input type="checkbox"/> YES → NO <input type="checkbox"/>	NO	←
11. TDA9178	<input type="checkbox"/> YES → NO <input type="checkbox"/>	NO	←
12. TONE IC	<input type="checkbox"/> YES → NO <input type="checkbox"/>	NO	←
13. FLAT	<input type="checkbox"/> YES → NO <input type="checkbox"/>	YES	←

SERVICE MENU SETTING ITEMS (TABLE 2)

Setting item	Setting value	Setting item	Setting value
1. IF	1. VCO 2. ATT [Do not adjust]	4. DEF.	1. V-SHIFT 2. V-SIZE 3. H-CENT 4. H-SIZE 5. TRAPEZ 6. EW-PIN 7. COR-PIN 8. COR-UP 9. COR-LO 10. ANGLE 11. BOW 12. V-S.CR 13. V.LIN
2. V / C	1. RGB BLK 2. WDR R 3. WDR G 4. WDR B 5. BRIGHT 6. CONTRAST 7. COLOUR 8. HUE 9. SHARP 10. VCO ADJUSTMENT 11. VIDEO AGC 12. SYNC SLICE		5. VSM PRESET COOL NORMAL WARM
3. AUDIO [Do not adjust]	1. ERR LIMIT 2. A2 ID THR	6. STATUS [Do not adjust]	VPS PDC

USER SETTING VALUE (TABLE 3)

Setting item	Setting value	Setting item	Setting value
SUB POWER	ON	VOLUME	Appropriate sound volume
SHIPPING CHANNEL	PR1	DISPLAY	INDICATED
PRESET CHANNEL	See OPERATING INSTRUCTIONS.	ZOOM MODE	PANORAMIC
PICTURE SETTING		EXT SETTING	
TINT	COOL	ID	BLANK
CONTRAST	CENTER	DUBBING	EXT-1→EXT-2
BRIGHT	CENTER		
SHARP	CENTER		
COLOUR	CENTER		
ECO MODE	OFF		
PICTURE FEATURES		FEATURES	
DIGITAL VNR	AUTO	SLEEP TIMER	OFF
COLOUR SYSTEM	TV : According to preset CH	BLUE BLACK	ON
4:3 AUTO ASPECT	EXT : AUTO	CHILD LOCK	ID : No.0000, ALL CH : OFF
PICTURE TILT	PANORAMIC	DECODER (EXT-2)	ALL CH : OFF
	CENTER		
SOUND SETTING		INSTALL	
BASS	CENTER	LANGUAGE	ENGLISH
TREBLE	CENTER	EDIT	PR CHANNEL ONLY
BALANCE	CENTER		OTHERS : BLANK
TV SPEAKER	L / R		
HYPERSOUND	OFF		
BBE	ON		

INITIAL SETTING VALUE OF SERVICE MENU

1. Adjustment of the SERVICE MENU is made on the basis of the initial setting values ; however, the new setting values which set the screen in its optimum condition may differ from the initial setting.
2. Do not change the initial Setting Values of the Setting (Adjustment) items not listed In "ADJUSTMENT".

1.IF

SETTING ITEM	INITIAL SETTING VALUE
1.VCO	Proper value by adjustment. See "adjustment of VCO" contents
2.ATT	Do not adjust this item.

2.VIDEO / CHROMA

is adjustment not to required

Colour system Setting item	Initial setting value			Colour system Setting item	Initial setting value		
	PAL	SECAM	NTSC		PAL	SECAM	NTSC
1. RGB BLK	—	—	—	7. COLOUR	000	000	000
2. WDR R	000	←	←	8. HUE	—	—	020
3. WDR G	000	←	←	9. SHARP	+007	←	←
4. WDR B	-012	←	←	10. VCO ADJUSTMENT	Automatically optimized after adjustment		
5. BRIGHT	000	←	←	11. VIDEO AGC	000	←	←
6. CONTRAST	000	←	←	12. SYNC SLICE	+007	←	←

3.AUDIO (Do not adjust)

Setting item	Variable range	Initial setting value (Fixed value)
1. ERR LIMIT	00H~FFH	10H
2. A2 ID THR	00H~FFH	19H

5.VSM PRESET

Setting item	VSM preset mode		
	COOL	NORMAL	WARM
1. CONT.	+12	0	-8
2. BRIGHT	-1	0	0
3. SHARP	-12	-12	-12
4. COLOUR	0	0	-1
5. HUE	0	0	0
6. WDR R	-25	0	+10
7. WDR G	-12	0	-2
8. WDR B	0	0	0

is adjustment not to required

4.DEF [AV32H10EUS]

Setting item	INITIAL SETTING VALUE							
	FULL		PANORAMIC		SUBTITLE		COMPRESS	
	100Hz i	120Hz i	100Hz i	120Hz i	100Hz i	120Hz i	100Hz i	120Hz i
1. V- SHIFT	-1	-8	0	0	11	-1	0	0
2. V-SIZE	3	-2	2	0	7	-15	-15	0
3. H-CENT	-11	1	-2	0	-1	0	0	0
4. H-SIZE	-20	0	-4	0	1	0	0	0
5. TRAPEZ	-9	-7	-2	0	1	0	0	0
6. EW-PIN	-21	1	0	0	0	0	0	0
7. COR-PIN	-18	-18	0	0	-3	0	0	0
8. COR-UP	17	-4	1	0	-6	0	0	0
9. COR-LO	16	15	0	0	3	0	0	0
10. ANGLE	0	0	0	0	0	0	0	0
11. BOW	0	0	0	0	0	0	0	0
12. V-S.CR	-16	0	0	0	0	0	0	0
13. V-LIN	-7	0	0	0	0	0	0	0

is adjustment not to required

4.DEF[AV28H10EUS]

Setting item	INITIAL SETTING VALUE							
	FULL		PANORAMIC		SUBTITLE		COMPRESS	
	100Hz i	60Hz p	100Hz i	60Hz p	100Hz i	60Hz p	100Hz i	120Hz i
1. V- SHIFT	-4	-8	1	0	11	-1	0	0
2. V-SIZE	9	-1	2	0	9	-15	0	0
3. H-CENT	-11	2	-2	0	1	0	0	0
4. H-SIZE	-26	-2	-4	0	0	0	0	0
5. TRAPEZ	-11	-10	-4	0	-2	0	0	0
6. EW-PIN	-46	4	0	0	1	0	0	0
7. COR-PIN	0	0	0	0	0	0	0	0
8. COR-UP	5	-26	-2	0	-8	0	0	0
9. COR-LO	-1	-14	-4	0	-4	0	0	0
10. ANGLE	0	0	0	0	0	0	0	0
11. BOW	0	0	0	0	0	0	0	0
12. V-S.CR	-3	0	7	0	-2	0	0	0
13. V-LIN	0	0	-11	0	-17	0	0	0

SERVICE ADJUSTMENTS

BEFORE STARTING SERVICE ADJUSTMENT

1. There are 2 ways of adjusting this TV: One is with the REMOTE CONTROL UNIT and the other is the conventional method using adjustment parts and components.
2. The setting (adjustment) using the REMOTE CONTROL UNIT is made on the basis of the initial setting values. The setting values which adjust the screen to the optimum condition can be different from the initial setting values.
3. Make sure that connection is correctly made to AC power source.
4. Turn on the power of the TV and measuring instrument for warming up for at least 30 minutes before starting adjustment.
5. If the receive or input signal is not specified, use the most appropriate signal for adjustment.
6. Never touch parts (such as variable resistors, transformers and condensers) not shown in the adjustment items of this service adjustment.
7. Preparation for adjustment (presetting)
Unless otherwise specified in the adjustment items, preset the following functions with the REMOTE CONTROL UNIT

USER MENU SETTING

ZOOM	PANORAMIC
PICTURE MODE (VSM)	NORMAL
TINT, CONTRAST, BRIGHT SHARP, COLOUR	CENTER
SLEEP TIMER	OFF
BALANCE	CENTER
ECO	OFF

MEASURING INSTRUMENT AND FIXTURES

1. DC voltmeter (or digital voltmeter)
2. Oscilloscope
3. Signal generator (Pattern generator) [PAL / SECAM / NTSC]
4. Remote control unit

ADJUSTMENT ITEMS

- Checking items.
- Adjustment of FOCUS and SCREEN.
- IF circuit adjustment.
- VSM preset setting.
- VIDEO / CHROMA circuit adjustment.
- DEFLECTION circuit adjustment.
- AUDIO circuit adjustment. **(Do not adjust)**

ADJUSTMENT LOCATIONS

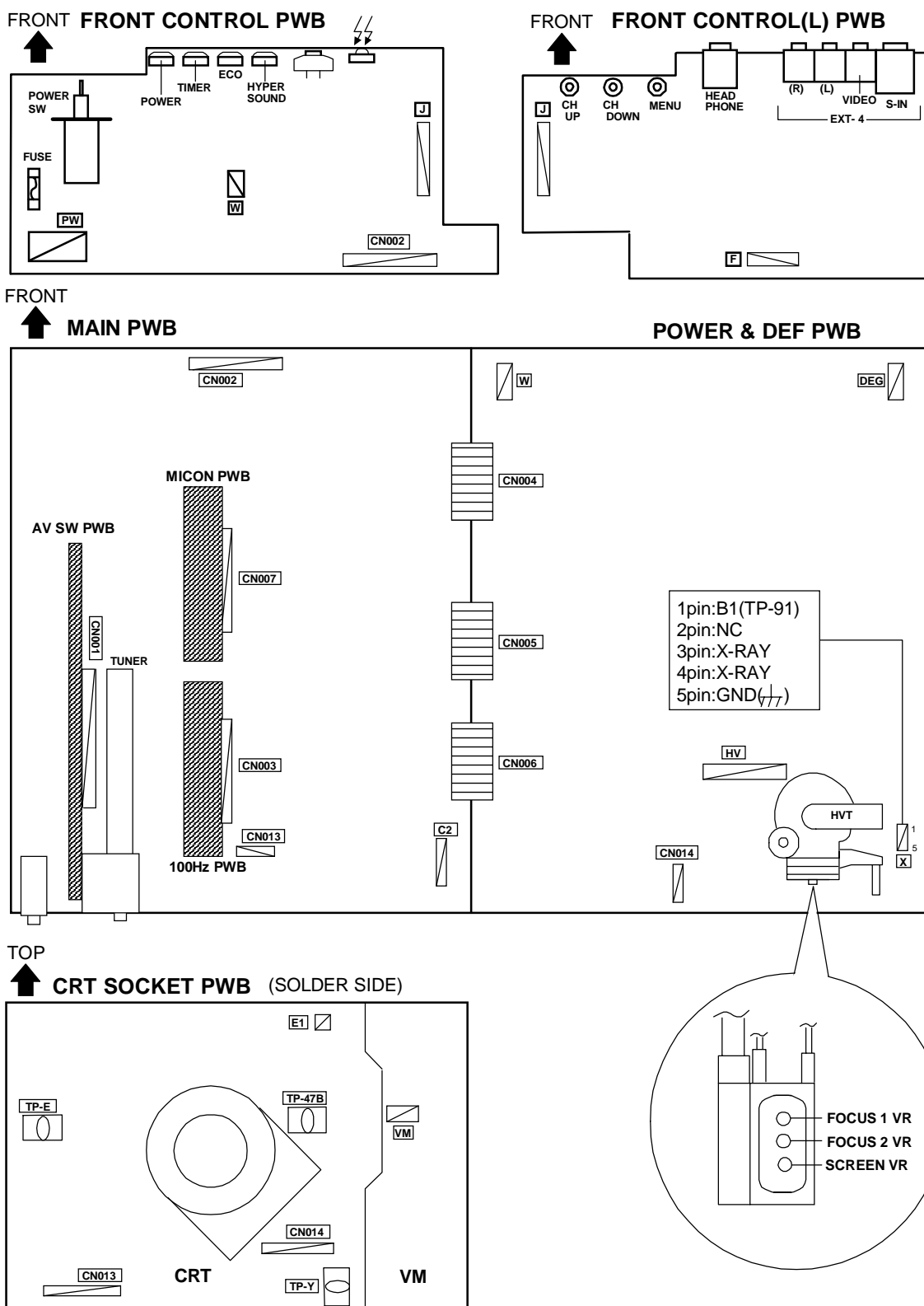

BASIC OPERATION SERVICE MENU

1. TOOL OF SERVICE MENU OPERATION

Operate the SERVICE MENU with the REMOTE CONTROL UNIT.

2. SERVICE MENU ITEMS

With the SERVICE MENU, various settings (adjustments) can be made, and they are broadly classified in the following items of settings (adjustments):

- (1) **1. IF** This mode adjusts the setting values of the IF circuit.
- (2) **2.V/C** This mode adjusts the setting values of the VIDEO / CHROMA circuit.
- (3) **3.AUDIO** This mode adjusts the setting values of the multiplicity SOUND circuit.
- (4) **4.DEF** This mode adjusts the setting values of the DEFLECTION circuit for each aspect mode given below.

ASPECT MODE	VERTICAL FREQUENCY and SCAN MODE
FULL	100Hz Inter-race / 60Hz Progressive
PANORAMIC	100Hz Inter-race / 60Hz Progressive
SUBTITLE	100Hz Inter-race / 60Hz Progressive

- (5) **5.VSM PRESET** This mode adjusts the initial setting values of COOL,NOMAL and WARM.
(VSM : Video Status Memory)

3. BASIC OPERATION OF SERVICE MENU

(1) How to enter SERVICE MENU

Press the **INFORMATION** key and the **MUTING** key of the REMOTE CONTROL UNIT simultaneously, and the SERVICE MENU screen of Fig. 1 will be displayed.

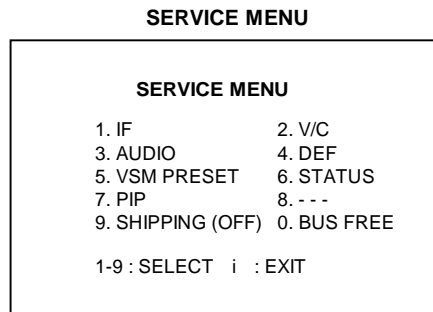

Fig.1

(2) Selection of SUB MENU SCREEN

Press one of keys 1~5 of the REMOTE CONTROL UNIT and select the SUB MENU SCREEN (See Fig. 3), form the SERVICE MENU.

SERVICE MENU → SUB MENU

1. IF
2. V / C
3. AUDIO
4. DEF.
5. VSM PRESET
6. STATUS
7. PIP
8. ---
9. SHIPPING (OFF)
0. BUSS FREE

Not to work

REMOTE CONTROL UNIT KEY ASSIGNMENT

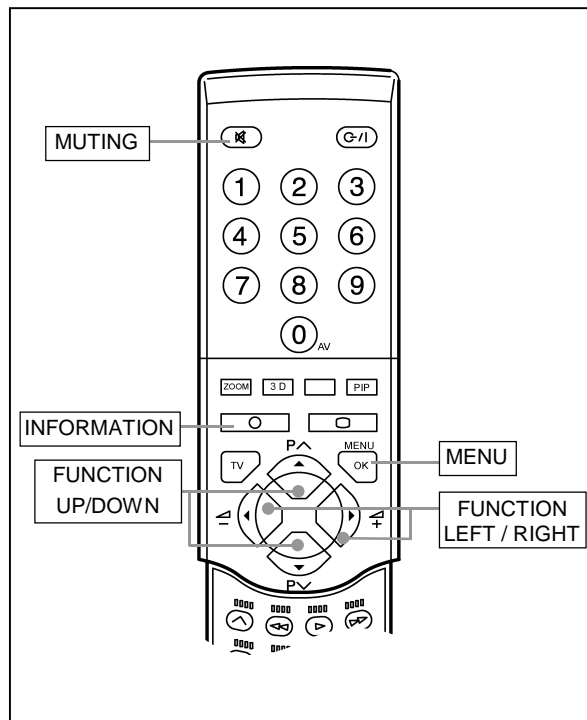

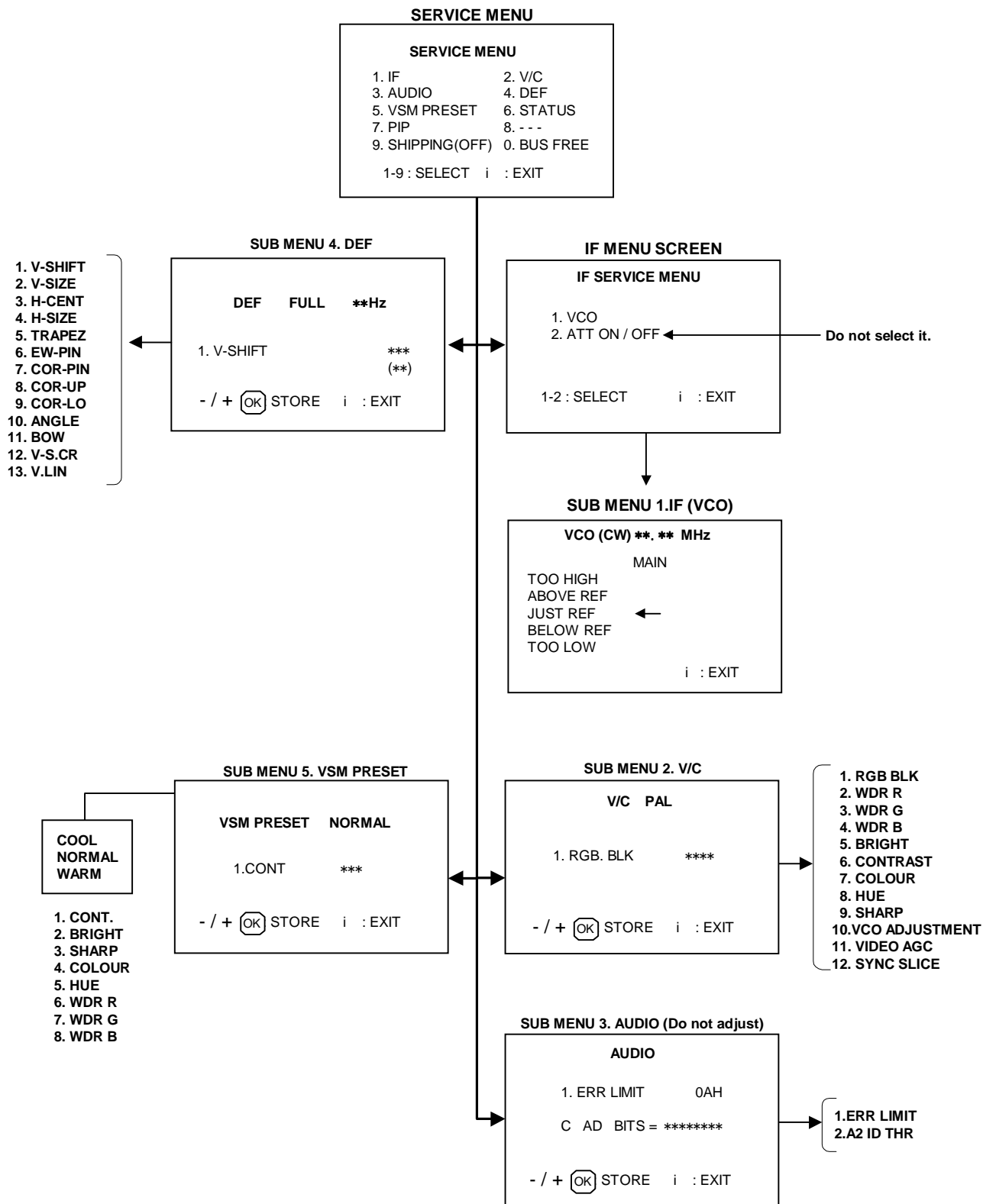

SUB MENU 5. VSM PRESET

VSM PRESET NORMAL

1.CONT ***

- / + OK STORE i : EXIT

COOL
NORMAL
WARM

- 1. CONT.
- 2. BRIGHT
- 3. SHARP
- 4. COLOUR
- 5. HUE
- 6. WDR R
- 7. WDR G
- 8. WDR B

SUB MENU 2. V/C

V/C PAL

1. RGB. BLK ****

- / + OK STORE i : EXIT

- 1. RGB BLK
- 2. WDR R
- 3. WDR G
- 4. WDR B
- 5. BRIGHT
- 6. CONTRAST
- 7. COLOUR
- 8. HUE
- 9. SHARP
- 10.VCO ADJUSTMENT
- 11. VIDEO AGC
- 12. SYNC SLICE

SUB MENU 3. AUDIO (Do not adjust)

AUDIO

1. ERR LIMIT 0AH

C AD BITS = *****

- / + OK STORE i : EXIT

- 1.ERR LIMIT
- 2.A2 ID THR

Setting methods

- Method of Setting **1.IF** as [VCO] : It must not adjust without signal.
 - ① 1 Key..... Select 1.IF.
 - ② 1 Key Select 1. VCO (CW)
Check the arrow position between the "ABOVE REF. and BELOW REF.
 - ③ INFORMATION Key..... Return to the SERVICE MENU screen.

- Method of setting **2.V/C, 3.AUDIO, 4.DEF** and **5.VSM PRESET**.
 - ① 2~5 Key..... Select one from **2. V/C, 3. AUDIO, 4. DEF** and **5. VSM PRESET**.
 - ② FUNCTION UP/DOWN Key Select setting items.
 - ③ FUNCTION LEFT/RIGHT Key..... Set (adjust) the setting values of the setting items.
 - ④ MENU (OK) Key Memorize the setting value.
(Before storing the setting values in memory, do not press the CH, TV, POWER ON / OFF key
- if you do, the values will not be stored in memory.)
 - ⑤ INFORMATION Key Return to the **SERVICE MENU** screen.

- Do not adjust **6. STATUS, 7. PIP, 8. --- , 9. SHIPPING(ON)** and **0. BUS FREE** function.

(4) Release of SERVICE MENU

- 1) After completing the adjustment, return to the SERVICE MENU, then again press the INFORMATION (OK) key to return to the normal screen.

ADJUSTMENT

CHECKING ITEM

Item	Measuring instrument	Test point	Adjustment part	Description
Check of B1 Power Supply	DC voltmeter Remote Control unit	TP-91(B1) TP-E(↵) [X connector on POWER & DEF PWB]	1.RGB BLK	<ol style="list-style-type: none"> 1. Receive any broadcast. 2. Press the ZOOM key and select the FULL mode. 3. Select 2. V/C from the SERVICE MENU. 4. Select 1. RGB BLK with FUNCTION UP / DOWN key. 5. Press the FUNCTION RIGHT key to turn on the cutoff screen condition (all black screen). 6. Connect a DC voltmeter to TP-91(B1) and TP-E(↵). 7. Make sure that the voltage is DC139.9 ±2.0V. 8. Press the function LEFT key to return to service menu.
Check of High Voltage	High voltage meter Remote Control unit	CRT anode Chassis GND	1.RGB BLK	<ol style="list-style-type: none"> 1. Receive any broadcast. 2. Press the ZOOM key and select the FULL mode. 3. Select 2. V/C from the SERVICE MENU. 4. Select 1. RGB BLK with FUNCTION UP / DOWN key. 5. Press the FUNCTION RIGHT key to turn on the cutoff screen condition (all black screen). 6. Connect a High voltage meter to CRT ANODE and chassis GND. 7. Make sure that the voltage is DC 31.0kV $\begin{matrix} +1kV \\ -1.5kV \end{matrix}$. 8. Press the function LEFT key to return to service menu.

ADJUSTMENT OF FOCUS AND SCREEN

Item	Measuring instrument	Test point	Adjustment part	Description
Adjustment of FOCUS	Signal generator		FOCUS 1 VR FOCUS 2 VR [In HVT]	<ol style="list-style-type: none"> 1. Receive a crosshatch signal. 2. By turning the FOCUS 2 VR, to make the vertical lines as fine and sharp as possible. 3. By turning the FOCUS 2 VR, adjust the picture so that the 6th vertical line from left side of the crosshatch picture becomes thinnest. 4. By turning the FOCUS 1 VR, adjust the 4th horizontal line from the upper side may become uniform at the line center and its periphery. 5. Carry out adjustment by repeating the steps 3 and 4 about. 6. Make sure that when the screen is darkened, the lines remain in good focus.

A schematic diagram of the HVT (High Voltage Transformer) showing three adjustment points: FOCUS 1 VR, FOCUS 2 VR, and SCREEN VR. The diagram shows a vertical component with a cylindrical top section and a rectangular base section. Three circular adjustment points are labeled on the right side of the base section.

A diagram showing a crosshatch pattern on a grid. The vertical lines are labeled 'FOCUS 2 VR' and the horizontal lines are labeled 'FOCUS 1 VR'. An arrow points to the intersection of a vertical and horizontal line, labeled 'Adjustment point'.

Item	Measuring instrument	Test point	Adjustment part	Description
Adjustment of SCREEN VR	Signal generator Remote control unit		SCREEN VR (Within FBT)	<ol style="list-style-type: none"> 1. Input the whole black signal. 2. Press the ZOOM key and select the FULL mode. 3. Select 2. V/C from the SERVICE MENU. 4. Turn the SCREEN VR clockwise from the full counterclockwise position, and stop it at the point where "CLOW" status (marked in figure) changes from "1" → "0" → "1" (which is indicated at the 3rd column from the right). 5. Then turn the SCREEN VR to the counterclockwise, and stop where "CLOW" status change "1" → "0".

Screen VR adjustment

IF CIRCUIT CHECKING

Item	Measuring instrument	Test point	Adjustment part	Description
Checking of VCO	Remote control unit IF MENU SCREEN		1.VCO	<ul style="list-style-type: none"> • Under normal conditions, no adjustment is required. Confirmation adjustment. <ol style="list-style-type: none"> 1. Select 1.IF from the SERVICE MENU. 2. Then select 1.VCO from the IF SERVICE MENU. 3. Receive any broadcast. 4. In the VCO adjustment screen, the yellow allows point to the characters. Check the allow position where pointed to the character from "ABOVE REF" to "BELOW REF".

VSM PRESET SETTING

Item	Measuring instrument	Test point	Adjustment part	Description
Setting of VSM PRESET	Remote control unit		1. CONT. 2. BRIGHT 3. SHARP 4. COLOUR 5. HUE 6. WDR R 7. WDR G 8. WDR B	1. Press the MENU key and select COOL mode with the remote control unit. 2. Select 5.VSM PRESET from the SERVICE MENU. 3. Adjust the FUNCTION UP/DOWN and LEFT/RIGHT key to bring the set values of 1.CONT ~ 8. WDR B to the values shown in the table. 4. Press the MENU key and memorize the set value. 5. Respectively select the VSM PRESET mode for NORMAL and WARM, and make similar adjustment as in 3 above. 6. Press the MENU key and memorize the set value. ★ Refer to OPERATING INSTRUCTIONS for the PICTURE MODE.

VIDEO/CHROMA CIRCUIT ADJUSTMENT

- The setting (adjustment) using the REMOTE CONTROL UNIT is made on the basis of the initial setting values.
- The setting values which adjust the screen to the optimum condition can be different from the initial setting values.

Item	Measuring instrument	Test point	Adjustment part	Description
Adjustment of WHITE BALANCE (High-Light)	Signal generator Remote control unit		2.WDR R 3.WDR G	<ul style="list-style-type: none"> ● Set the PICTURE MODE to NORMAL. 1. Receive a black and white signal (colour off). 2. Select 2. V/C from the SERVICE MENU. 3. Modify 2. WDR R and 3.WDR G data to adjust the white balance (high light). 4. Press the MENU key and memorize the set value. 5. Change the contrast and brightness up and down with the remote control unit from Low-light to High-light, and check that the tracking of the white balance is good.
Adjustment of SUB BRIGHT	Remote control unit		5.BRIGHT	1. Receive any broadcast. 2. Select 2.V/C from the SERVICE MENU. 3. Select 5.BRIGHT with the FUNCTION UP/DOWN key. 4. Set the initial setting value with the FUNCTION LEFT/RIGHT key. 5. If the brightness is not the best with the initial setting value, make fine adjustment until you get the best brightness. 6. Press the MENU key and memorize the set value.
Adjustment of SUB CONTRAST	Remote control unit		6.CONTRAST	1. Receive any broadcast. 2. Select 2.V/C from the SERVICE MENU. 3. Select 6.CONTRAST with the FUNCTION UP/DOWN key. 4. Set the initial setting value with the FUNCTION LEFT/RIGHT key. 5. If the contrast is not the best with the initial setting value, make fine adjustment until you get the best contrast. 6. Press the MENU key and memorize the set value.

Item	Measuring instrument	Test point	Adjustment part	Description
Adjustment of SUB COLOUR I	Remote control unit		7.COLOUR (PAL/SECAM/NTSC)	[Method of adjustment without measuring instrument]
			PAL COLOUR	<ol style="list-style-type: none"> 1. Receive PAL broadcast. 2. Select 2.V/C from the SERVICE MENU. 3. Select 7.COLOUR with the FUNCTION UP/DOWN key. 4. Set the initial setting value for PAL COLOUR with the FUNCTION LEFT/RIGHT key. 5. If the colour is not the best with the initial set value, make fine adjustment until you get the best colour. 6. Press the MENU key and memorize the set value.
			SECAM COLOUR	<ol style="list-style-type: none"> 1. Receive a SECAM broadcast. 2. Make fine adjustment of SECAM COLOUR in the same manner as for above.
			NTSC COLOUR	<p>(NTSC 3.58 COLOUR)</p> <ol style="list-style-type: none"> 1. Input a NTSC 3.58MHz COMPOSITE VIDEO signal from the EXT terminal. 2. Make similar fine adjustment of NTSC 3.58 COLOUR in the same manner as for above. <p>(NTSC 4.43 COLOUR)</p> <ol style="list-style-type: none"> 1. Input a NTSC 4.43MHz COMPOSITE VIDEO signal from the EXT terminal. 2. Make similar fine adjustment of 4.43 COLOUR in the same manner as for above.

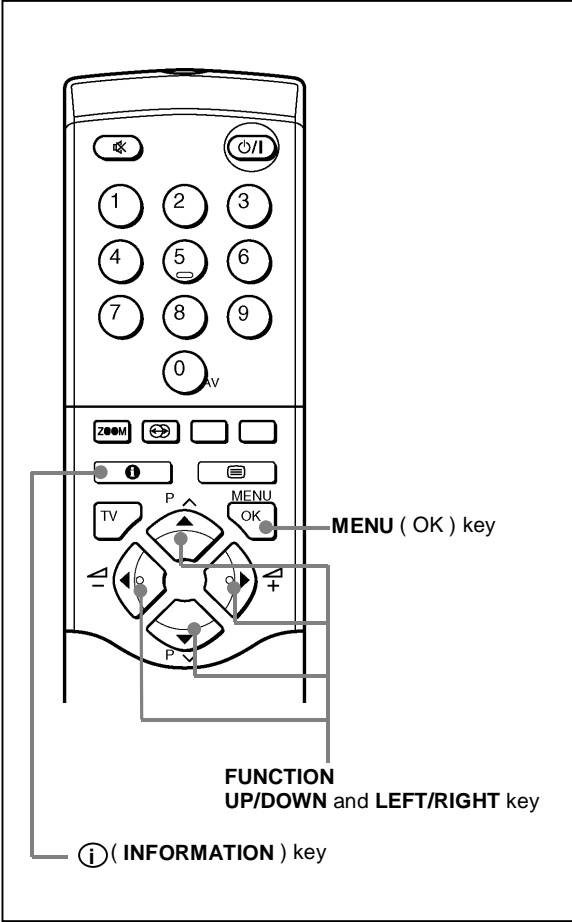

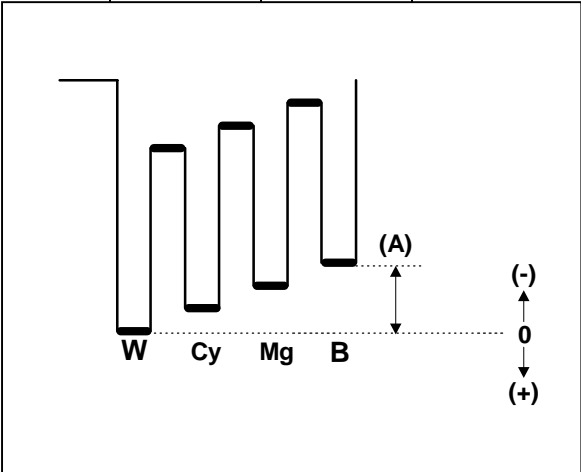
Item	Measuring instrument	Test point	Adjustment part	Description						
Adjustment of SUB COLOUR II	Signal generator	TP-47B TP-E(↕)	7.COLOUR (PAL/SECAM/NTSC)	<p>[Method of adjustment using measuring instrument]</p> <ol style="list-style-type: none"> 1. Receive a PAL full field colour bar signal (75% white). 2. Select 2.V/C from the SERVICE MENU. 3. Select 7.COLOUR with the FUNCTION UP/DOWN key. 4. Set the initial setting value of PAL COLOUR with the FUNCTION LEFT/RIGHT key. 5. Connect the oscilloscope between TP-47B and TP-E 6. Adjust PAL COLOUR and bring the value of (A) in the illustration to the value in the table (voltage difference between white (w) and blue (B)). 7. Press the MENU key and memorize the setting value. <table border="1" data-bbox="927 875 1481 1016"> <thead> <tr> <th>MODEL NAME</th> <th>PAL COLOUR adjustment</th> </tr> </thead> <tbody> <tr> <td>AV32H10EUS</td> <td>+5V</td> </tr> <tr> <td>AV28H10EUS</td> <td>+5V</td> </tr> </tbody> </table>	MODEL NAME	PAL COLOUR adjustment	AV32H10EUS	+5V	AV28H10EUS	+5V
	MODEL NAME	PAL COLOUR adjustment								
	AV32H10EUS	+5V								
AV28H10EUS	+5V									
Oscilloscope	[CRT SOCKET PWB]	PAL COLOUR								
Remote control unit										
										
			SECAM COLOUR	<ol style="list-style-type: none"> 1. Receive a SECAM full field colour bar signal (75% white). 2. Set the initial setting value of SECAM COLOUR with the FUNCTION LEFT/RIGHT key. 3. Adjust SECAM COLOUR and bring the value of (A) of the illustration to the value in the table (W~B). 4. Press the MENU key and memorize the setting value. <table border="1" data-bbox="932 1301 1485 1447"> <thead> <tr> <th>MODEL NAME</th> <th>SECAM COLOUR adjustment</th> </tr> </thead> <tbody> <tr> <td>AV32H10EUS</td> <td>+4V</td> </tr> <tr> <td>AV28H10EUS</td> <td>+4V</td> </tr> </tbody> </table>	MODEL NAME	SECAM COLOUR adjustment	AV32H10EUS	+4V	AV28H10EUS	+4V
MODEL NAME	SECAM COLOUR adjustment									
AV32H10EUS	+4V									
AV28H10EUS	+4V									
			NTSC COLOUR	<p>(NTSC 3.58 COLOUR)</p> <ol style="list-style-type: none"> 1. Input a NTSC 3.58MHz COMPOSITE VIDEO signal (full field colour bar with 75% white) from the EXT terminal. 2. Set the initial setting value of NTSC 3.58 COLOUR with the FUNCTION LEFT/RIGHT key. 3. Adjust NTSC 3.58 COLOUR and bring the value of (A) of the illustration to the value in the table (W~B). 4. Press the MENU key and memorize the setting value. <table border="1" data-bbox="932 1787 1485 1933"> <thead> <tr> <th>MODEL NAME</th> <th>NTSC COLOUR adjustment</th> </tr> </thead> <tbody> <tr> <td>AV32H10EUS</td> <td>+11V</td> </tr> <tr> <td>AV28H10EUS</td> <td>+6V</td> </tr> </tbody> </table> <p>(NTSC 4.43 COLOUR)</p> <ol style="list-style-type: none"> 1. When NTSC3.58 adjustment has done, then NTSC4.43 adjustment will be automatically set at the respective values. 	MODEL NAME	NTSC COLOUR adjustment	AV32H10EUS	+11V	AV28H10EUS	+6V
MODEL NAME	NTSC COLOUR adjustment									
AV32H10EUS	+11V									
AV28H10EUS	+6V									

Item	Measuring instrument	Test point	Adjustment part	Description
Adjustment of SUB HUE I	Remote control unit		8.HUE	[Method of adjustment without measuring instrument]
			NTSC 3.58 HUE	<ol style="list-style-type: none"> 1. Input a NTSC 3.58MHz COMPOSITE VIDEO signal (full field colour bar with 75% white) from the EXT terminal. 2. Select 2.V/C from the SERVICE MENU. 3. Select 8.HUE with the FUNCTION UP/DOWN key. 4. Set the initial setting value of NTSC 3.58 HUE with the FUNCTION LEFT/RIGHT key. 5. If you cannot get the best hue with the initial setting value, make fine adjustment until you get the best hue. 6. Press the MENU key and memorize the set value.
			NTSC 4.43 HUE	<ol style="list-style-type: none"> 1. When NTSC 3.58 is set, NTSC 4.43 will be automatically set at the respective values.
Adjustment of SUB HUE II	Signal generator	TP-47B TP-E(↕) [CRT SOCKET PWB]	8.HUE	[Method of adjustment using measuring instrument]
	Oscilloscope		NTSC 3.58 HUE	<ol style="list-style-type: none"> 1. Input a NTSC 3.58MHz COMPOSITE VIDEO signal (full field colour bar with 75% white) from the EXT terminal. 2. Select 2.V/C from the SERVICE MENU. 3. Select 8.HUE with the FUNCTION UP/DOWN key. 4. Set the initial setting value of NTSC 3.58 HUE with the FUNCTION LEFT/RIGHT key. 5. Connect the oscilloscope between TP-47B and TP-E 6. Adjust NTSC 3.58 HUE to bring the value of (B) in the illustration to the value in the table (voltage difference between white (W) and magenta (Mg)). 7. Press the MENU key and memorize the setting value
	Remote control unit		NTSC 4.43 HUE	<ol style="list-style-type: none"> 1. When NTSC 3.58 is set, NTSC 4.43 will be automatically set at the respective values.

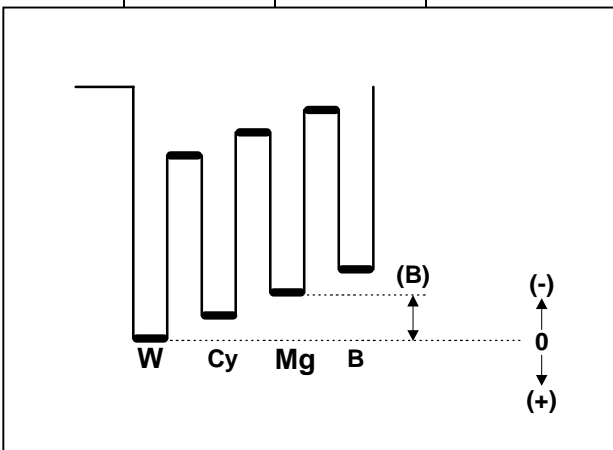

MODEL NAME	NTSC HUE adjustment
AV32H10EUS	-1V
AV28H10EUS	-3V

Item	Measuring instrument	Test point	Adjustment part	Description
Adjustment of VCO for colour decoder	Signal generator Remote control unit		10. VCO	<ol style="list-style-type: none"> 1. Input a PAL full field colour bar signal (75% white) from the EXT terminal. 2. Select 2. V/C from the SERVICE MENU. 3. Select 10. VCO adjustment with the FUNCTION UP/DOWN key. 4. Press the OK key then automatically optimized.

DEFLECTION CIRCUIT ADJUSTMENT

There are 4 aspect modes (①FULL, ②PANORAMIC, ③SUBTITLE, ④COMPRESS) of the adjustment (1) 100Hz i mode, (2) 60Hz p and (3) 120Hz i mode..... depending upon the kind of signals (vertical frequency 100Hz i / 60Hz p / 120Hz i). Character "i" is an omission of "inter laced scan", and character "p" is an omission of "progressive scan".

- When the 100Hz FULL mode has been established, the setting of other modes will be done automatically. However, if the picture quality has not been optimized, adjust each mode again, respectively.
- The adjustment using the remote control unit is made on the basis of the initial setting values.
- The setting values which adjust the screen to the optimum condition can be different from the initial setting values.

Item	Measuring instrument	Test point	Adjustment part	Description
Adjustment of V-SHIFT	Signal generator Remote control unit		1.V- SHIFT	<ul style="list-style-type: none"> ● Set the ASPECT MODE to FULL. <ol style="list-style-type: none"> 1. Receive a circle pattern signal of vertical frequency 50Hz. 2. Select 4.DEF from the SERVICE MENU. 3. Select 1.V-SHIFT with the FUNCTION UP/DOWN key. 4. Adjust V-SHIFT to make A = B. 5. Check the adjustment condition in other zoom mode. If it is a wrong condition, re-adjust in "FULL" mode with 1. V-SHIFT. 6. Press the MENU key and memorize the set value.

Item	Measuring instrument	Test point	Adjustment part	Description												
Adjustment of V-SIZE	Signal generator Remote control unit		2.V-SIZE	7. Receive a crosshatch signal. 8. Select 2.V-SIZE and set the initial setting value. 9. Adjust V-SIZE to the vertical screen size of the picture becomes the value given table below. 10. Press the MENU key and memorize the set value. 11. Input a NTSC VIDEO signal (60Hz) from the EXT terminal, and make sure that the vertical screen size is in the table below. 12. Press the MENU key and memorize the set value.												
<table border="1"> <thead> <tr> <th>SCREEN POSITION \ ASPECT</th> <th>FULL</th> <th>PANORAMIC</th> <th>SUB TITLE</th> </tr> </thead> <tbody> <tr> <td>TOP</td> <td>92%</td> <td>87%</td> <td>70%</td> </tr> <tr> <td>BOTTOM</td> <td>92%</td> <td>87%</td> <td>83%</td> </tr> </tbody> </table> <p>[VERTICAL SCREEN SIZE]</p>					SCREEN POSITION \ ASPECT	FULL	PANORAMIC	SUB TITLE	TOP	92%	87%	70%	BOTTOM	92%	87%	83%
SCREEN POSITION \ ASPECT	FULL	PANORAMIC	SUB TITLE													
TOP	92%	87%	70%													
BOTTOM	92%	87%	83%													
Adjustment of H. CENTER	Signal generator Remote control unit		3.H-CENT.	13. Receive a circle pattern signal. 14. Select 3.H-CENT and set the initial setting value. 15. Adjust H-CENT to make $C=D$. 16. Press the MENU key and memorize the set value.												

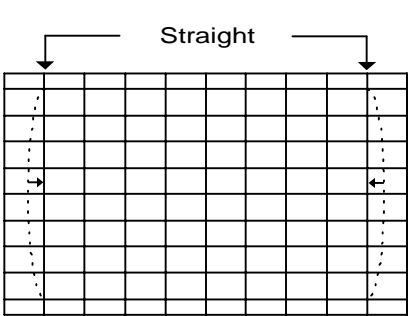
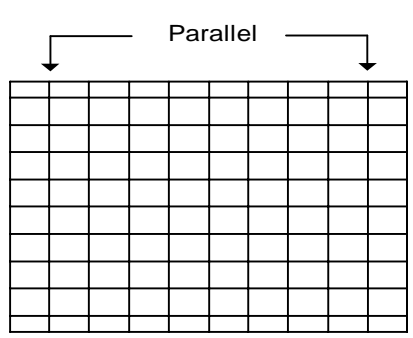
Item	Measuring instrument	Test point	Adjustment part	Description								
Adjustment of H.SIZE	Signal generator		4.H-SIZE	17. Receive a crosshatch signal. 18. Select 4.H-SIZE and set the initial setting value. 19. Adjust H-SIZE and make sure that the horizontal screen size of the picture is in the table below. 20. Press the MENU key and memorize the set value. 21. Input the NTSC VIDEO signal (60Hz) from the EXT terminal, and make sure that the horizontal screen size is in the table below. 22. Press the MENU key and memorize the set value.								
	Remote control unit											
<table border="1" style="width: 100%; border-collapse: collapse;"> <thead> <tr> <th style="width: 25%;">ASPECT MODE</th> <th style="width: 25%;">FULL</th> <th style="width: 25%;">PANORAMIC</th> <th style="width: 25%;">SUBTITLE</th> </tr> </thead> <tbody> <tr> <td style="text-align: center;">H SIZE</td> <td style="text-align: center;">92%</td> <td style="text-align: center;">95%</td> <td style="text-align: center;">92%</td> </tr> </tbody> </table> <p style="text-align: center;">[HORIZONTAL SCREEN SIZE]</p>					ASPECT MODE	FULL	PANORAMIC	SUBTITLE	H SIZE	92%	95%	92%
ASPECT MODE	FULL	PANORAMIC	SUBTITLE									
H SIZE	92%	95%	92%									
Adjustment of EW-PIN	Signal generator Remote control unit		6.EW-PIN	23. Select 6.EW-PIN and set the initial setting value 24. Adjust EW-PIN and make the 2nd.vertical lines at the left and right edges of the screen straight. Also make sure that the 3rd vertical lines are straight. 25. Press the MENU key and memorize the set value.								
												
Adjustment of TRAPEZ	Signal generator Remote control unit		5.TRAPEZ	26. Receive a crosshatch signal. 27. Select 5.TRAPEZ with the FUNCTION UP/DOWN key. 28. Set the initial setting value of 5.TRAPEZ with the FUNCTION LEFT/RIGHT key. 29. Adjust TRAPEZ and bring the vertical lines at the right and left edges of the screen parallel. 30. Press the MENU key and memorize the set value.								
												

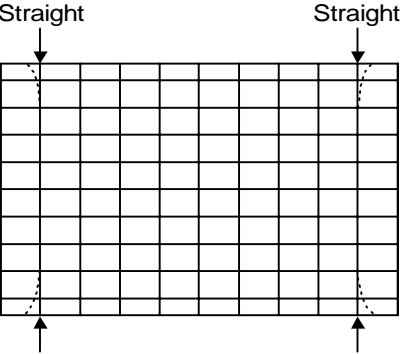
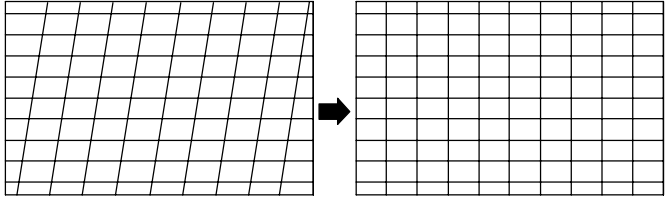
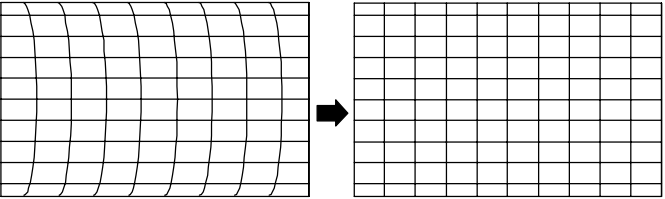
Item	Measuring instrument	Test point	Adjustment part	Description
Adjustment of CORNER UP/ LOW	Signal generator Remote control unit		7.COR-PIN 8.COR-UP 9.COR-LO	31. Select 9.COR-LO with the FUNCTION UP/DOWN key. 32. Set the initial setting value of COR-LO with the FUNCTION LEFT/RIGHT key. 33. Adjust COR-LO, and bring the lines at the low corner straight. 34. Select 8.COR-UP with the FUNCTION UP/DOWN key. 35. Set the initial setting value of COR-UP with the FUNCTION LEFT/RIGHT key. 36. Adjust COR-UP, and bring the lines at the upper corner straight. 37. If the extreme upper & lower corners have pin or barrel condition a little chose 7.COR-PIN and adjust it to get the straight. 38. Press the MENU key and memorize the set value.
				
Adjustment of ANGLE	Signal generator Remote control unit		10.ANGLE	<ul style="list-style-type: none"> ● In case which there is a parallelogram distortion of images on the screen. 39. Select 10.ANGLE with the FUNCTION UP/DOWN key. 40. Adjust ANGLE, and bring the vertical lines straight. 41. Press the MENU key and memorize the set value.
 <p style="text-align: center;">PARALLELOGRAM</p>				
Adjustment of BOW	Signal generator Remote control unit		11.BOW	<ul style="list-style-type: none"> ● In case where there is a bow-shaped distortion of images on the screen. 42. Select 11.BOW with the FUNCTION UP/DOWN key. 43. Adjust BOW, and bring the vertical lines straight. 44. Press the MENU key and memorize the set value.
 <p style="text-align: center;">BOW</p>				

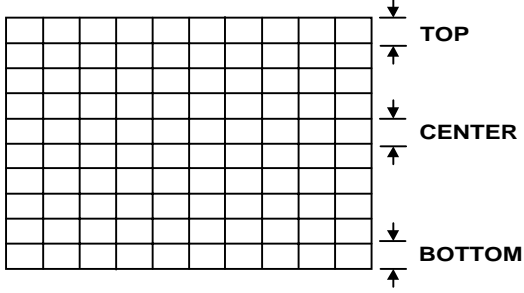
Item	Measuring instrument	Test point	Adjustment part	Description
Adjustment of V-S.CR & V.LINE	Signal generator Remote control unit		12.V-S.CR 13.V.LINE.	<ul style="list-style-type: none"> When the vertical linearity has been deteriorated remarkably, perform the following steps. <ol style="list-style-type: none"> Receive a crosshatch signal. Select 13. V.LINE with the FUNCTION UP / DOWN key. Set the initial setting value of 13. V.LINE with the FUNCTION LEFT/RIGHT key. Select 12. V-S.CR. with the FUNCTION UP / DOWN key. Set the initial setting value of 12. V-S.CR. with the FUNCTION LEFT/RIGHT key. Adjust 13. V.LINE and 12. V-S.CR. to the spaces of each lines at TOP, CENTER, and BOTTOM become uniform. <p>NOTE : Do not adjust in "PANORAMIC" and "SUBTITLE" mode.</p>
				<p>At first the adjustment in 100Hz FULL mode should be done, then the data for the other aspect mode is corrected in the respective value at the same time. And confirm the deflection adjustment initial setting value in 120Hz (NTSC EXT mode) FULL mode. If the adjustment in 100Hz each aspect mode has been done and stored, the data for the same aspect modes in 120Hz is corrected in the respective value. Only the data for the other aspect mode in 120Hz is corrected for itself.</p>

AUDIO CIRCUIT ADJUSTMENT

Do not adjust **3. AUDIO** adjustment of the SERVICE MENU as it requires no adjustment.

If values had changed by some reason, set the initial setting values in the table given before page.

REPLACEMENT OF CHIP COMPONENT

■ CAUTIONS

1. Avoid heating for more than 3 seconds.
2. Do not rub the electrodes and the resist parts of the pattern.
3. When removing a chip part, melt the solder adequately.
4. Do not reuse a chip part after removing it.

■ SOLDERING IRON

1. Use a high insulation soldering iron with a thin pointed end of it.
2. A 30w soldering iron is recommended for easily removing parts.

■ REPLACEMENT STEPS

1. How to remove Chip parts

◆ Resistors, capacitors, etc

- (1) As shown in the figure, push the part with tweezers and alternately melt the solder at each end.

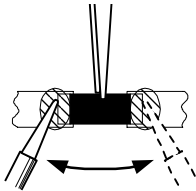

- (2) Shift with tweezers and remove the chip part.

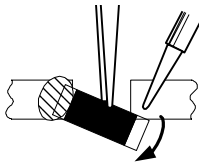

◆ Transistors, diodes, variable resistors, etc

- (1) Apply extra solder to each lead.

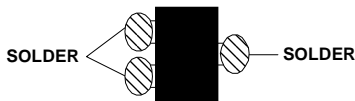

- (2) As shown in the figure, push the part with tweezers and alternately melt the solder at each lead. Shift and remove the chip part.

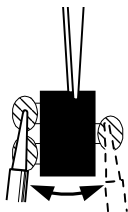

Note : After removing the part, remove remaining solder from the pattern.

2. How to install Chip parts

◆ Resistors, capacitors, etc

- (1) Apply solder to the pattern as indicated in the figure.

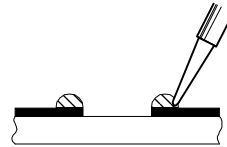

- (2) Grasp the chip part with tweezers and place it on the solder. Then heat and melt the solder at both ends of the chip part.

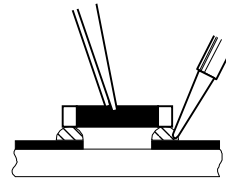

◆ Transistors, diodes, variable resistors, etc

- (1) Apply solder to the pattern as indicated in the figure.
- (2) Grasp the chip part with tweezers and place it on the solder.
- (3) First solder lead **A** as indicated in the figure.

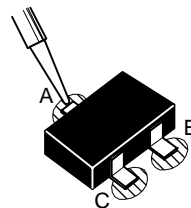

- (4) Then solder leads **B** and **C**.

